



Seanactiv™

Use the power of fucoidan to quickly erase eye-aging and improve healthy radiance

October 2021

Care
Creations™

■ ■ **BASF**

We create chemistry

Presenters



- Meg Mullen – Marketing Manager, Actives, North America



- Allison Garlet – Technical Services Specialist, Actives

Warning: Contains Some Claims not valid in the United States

- ⊘ Some of the claims and other information presented in the following materials are informational in nature and **may not be used in any promotion, marketing, or information relating to products intended for sale in the United States or communicated to U.S. consumers.** Such prohibited claims are identified on the applicable slide.
- ⊘ The prohibited claims and information are outside of the scope of authorized claims allowed by U.S. Food and Drug Administration (FDA) regulations, and may not meet legal, regulatory, and/or scientific standards for claims under U.S. law.
- ⊘ Use of these prohibited claims in the U.S. may result in administrative, civil, or criminal liability for the disseminator under laws and regulations enforced by U.S. government authorities.
- ⊘ BASF and its affiliates specifically prohibit and disclaim the use or targeting of such claims to a U.S. audience and are not liable for any such claims made by the disseminator.

Seanactiv Agenda



Consumer desire for help with the eye contour

What are the needs? How is eye contour affected? Our solutions?

Interest in Algae → Seanactiv

Why algae are good for skin?
What is our algae extract?
Our Product

Seanactiv package efficacy

In Vitro and *in vivo* package on the 3 biomarkers linked to eye contour improvement
Characteristics and concept

Seanactiv Agenda



Consumer desire for help with the eye contour

What are the needs? How is eye contour affected? Our solutions?

Interest for Algae → Seanactiv

Why algae are good for skin?
What is our algae extract?
Our Unique Selling Proposal

Seanactiv package efficacy

Vitro and vivo package on the 3 biomarkers linked to eye contour improvement
Characteristics and concept

Our eyes are unique

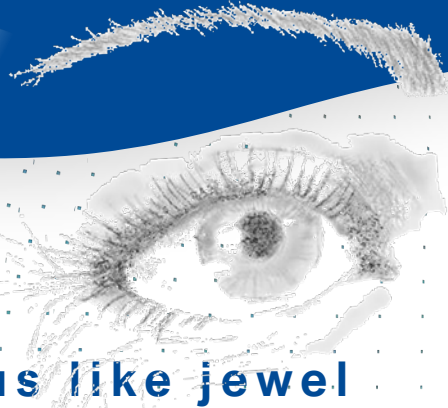

❑ Precious like jewel

Taking care of our eyes is essential to limit visible signs of fatigue and aging

❑ Reflection of age and soul

Eye contour area is quickly affected by our environment; eye contour showing not only the age and the fatigue, but also stress, emotions, ...

❑ Define the right routine

The skin around the eyes is very thin, a proper skincare routine is a key as well as a good life hygiene, an optimized hydration and sun protection

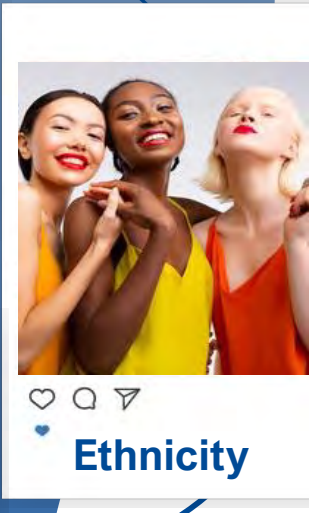
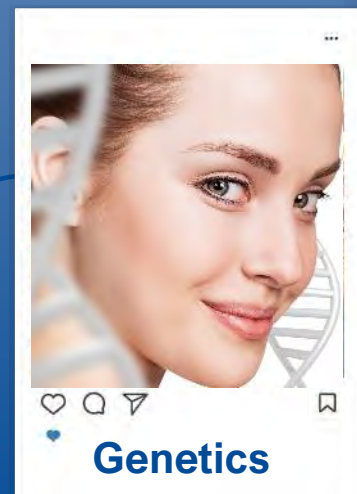
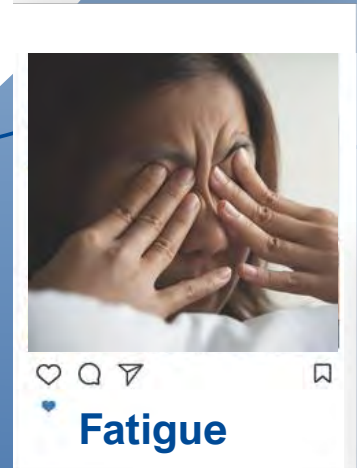
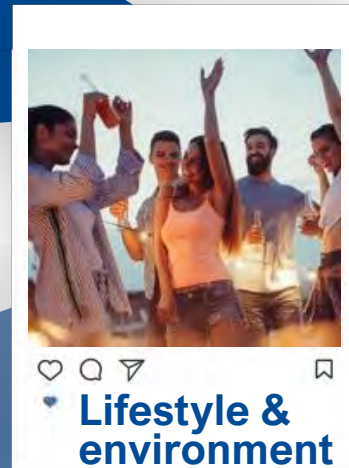
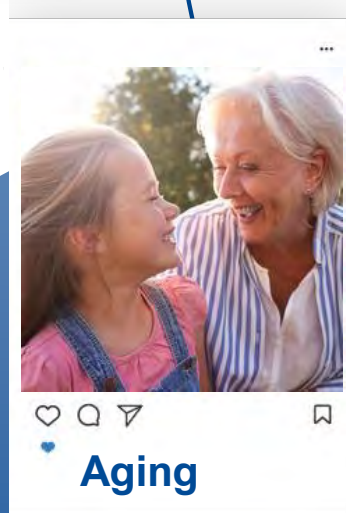

Our eyes are fragile

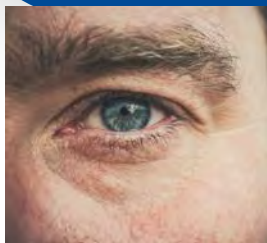

Skin luminosity & Dullness

With age and lifestyle, skin becomes more fragile and loses vitality

- need to **restore** cell activity
- need to **boost radiance**



Dark circles Puffiness

Dark circles and puffiness are related to blood leakage or microcirculation defect

- need to **protect** the epidermis from **toxic Heme** release



Crow's feet and Fine lines

Wrinkles are related to the **perception of aging and tiredness** on the skin

- Need to **stimulate** collagen production



Droopy eyelid

Skin sagging results in an alteration of the mechanical properties of the skin

- Need to **densify, regenerate and lift the skin**

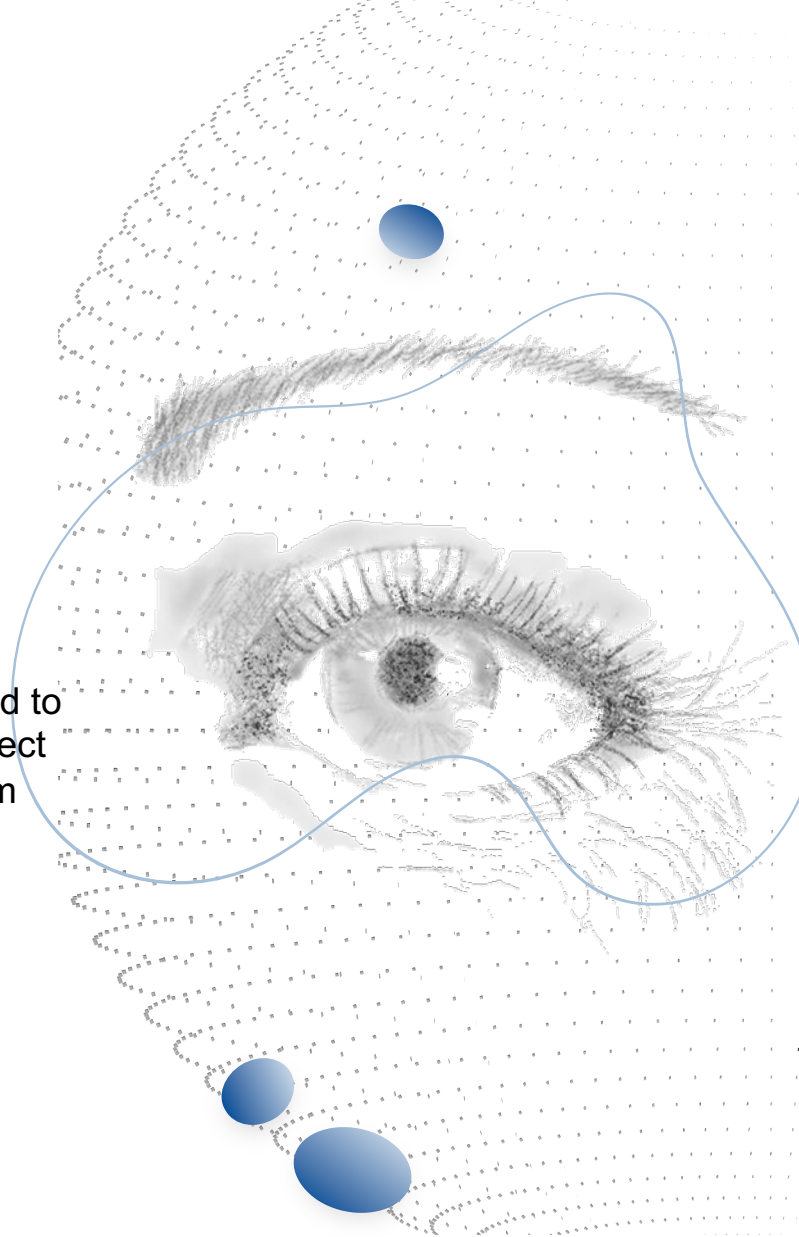

BASF
We create chemistry

Care
Creations.

NOTE: The above claims may not be used in any promotion, marketing, or information relating to products intended for sale or reasonably anticipated for use in the United States.

Listening to consumers

Consumer seek safe products that can protect their eye contour, limiting **signs of fatigue, dark circles and puffiness**

44 %

of Thai consumers* would like their diet to help improve their eye health

23 %

of UK women say their eyes are their biggest concern when it comes to maintaining their skin

96 %

of consumers want to reduce dark circles

66 %

of consumers want to decrease signs of aging

79 %

of Chinese consumers agree that current society puts too much pressure on people to look youthful



What do we find on the market?

Concerns about eye health

Tired eyes can indicate low energy levels, so it makes sense to offer eye health benefits. **Consumer seek safe products that can protect their eye contour, limiting signs of fatigue, dark circles and puffiness**



GUERLAIN

Orchid Noble Light™ Technology to act on the main sources of skin dullness and **recreating exceptional light**. Day after day, the eye contour is **smoother, dark circles and puffiness are minimized, and the eye area lights up**.



GLACYO

An impressive blend of 69 Glacial Marine Minerals and Earth Elements, Amber Extract, and Botanical Oils. Help to **reduce puffiness and dark circles** under the eyes, as well as **diminish wrinkles and fine lines** while renewing skin cells.



GLAMGLOW

An illuminating eye cream with illuminating spheres, peptides, caffeine and hyaluronic acid, that instantly **brightens dark circles and reduces the visible signs of fatigue** around the entire eye area for a **super well-rested, glowing look**.



SENSAI

Promote collagen synthesis, **stimulate microcirculation** and thus bring a lifting effect to the contours of the face for firmer, smoother and brighter skin.

Third-party product names and images are used for reference only and are not intended to suggest endorsement by, or an existing licensing relationship with, the trademark owner.

BASF

Care
Creations

Our inspiring solutions

Multi-purpose bioactive

Inolixir® : decreases Dark circles and signs of fatigue in 1 week

Shadownyl® Clear: decrease wrinkles in 1 week and Dark circles in 2 weeks

Puffiness focus

Flavagrum® instantly reduce bags thanks to immediate tissue draining and free radical scavenging

Botanical flower complex

Biophytex® to reduce Dark circles in 4 weeks

→NEW Seanactiv

The BASF Solutions

For today and tomorrow

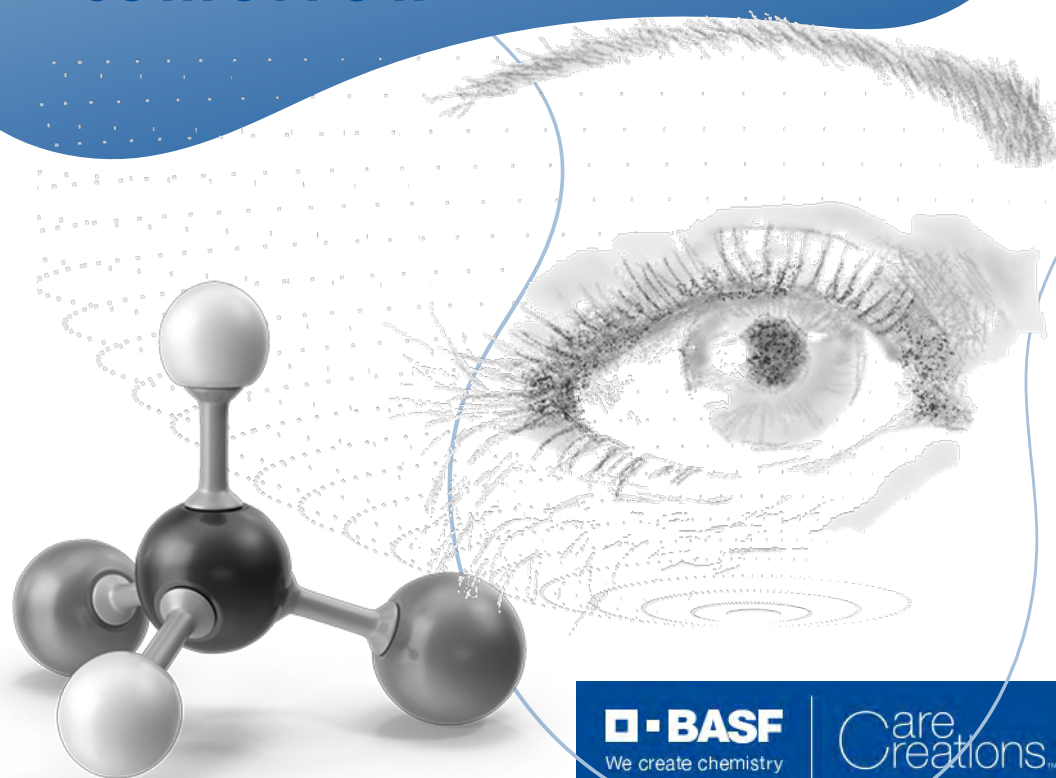

BASF
We create chemistry

Care
Creations.

NOTE: The above claims may not be used in any promotion, marketing, or information relating to products intended for sale or reasonably anticipated for use in the United States.

Seanactiv

Who hasn't dreamt about even, smoother, younger, more luminous eyes in a snap?

Inspired by the power of the ocean, BASF presents

SEANACTIV

new bioactive using the power of fucoidans to help decrease the signs of aging around the eye and help create a healthier & fresher look.



In as few as 7 days!



**Dark circles are reduced
Crow's feet are fading
The eye contour looks healthier & fresher**

Seanactiv Agenda

Consumer request for the eye contour

What are the needs? How is eye contour affected?
Our solutions?

Interest in Algae → Seanactiv

Why algae are good for skin?
What is our algae extract?
Our Unique Product

Seanactiv package efficacy

Vitro and vivo package on the 3
biomarkers linked to eye contour
improvement
Characteristic and concept



Superpower of algae

□ Reassuring and well-known

Used in nutrition as superfood, in fashion to create adaptable clothes, also able to absorb CO₂ and reduce environmental footprint, and in beauty for their healthy properties (thalassotherapy, wellness, slimming..)

□ Extremophile Superfood

Photosynthetic organisms that can grow under extreme conditions and retain high concentrations of a wide variety of health-sustaining ingredients

□ Sustainable polysaccharides source

Due to high polysaccharides content and presence of essential amino acids in its composition, combined with the fact that it needs minimal resource requirements for growth.

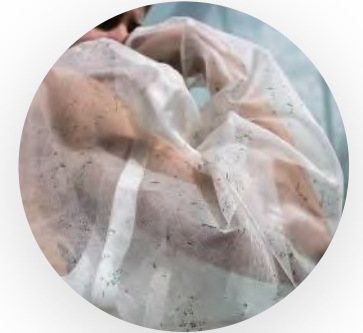



Q | consumers' interests for **algae**

What are the main benefits of algae? In food? In fashion? What are the properties for beauty?

What do people need/want/wish when it comes to skin?



26%

Of skincare launches in the last 12 months with algae inside

High and growing interest of consumer for algae



Existing BASF solution from algae

Shadownyl Clear with *Fucus Vesiculosus* Extract
Slim-Excess with Hydrolyzed Rhodophycea Extract



Our alga

Fucus vesiculosus



Seanactiv

Fucus vesiculosus extract

Fucus vesiculosus, commonly known as



bladderwrack



Well-known properties

Antioxidant, antibacterial, antifungal, anticoagulant.



Nutrition

Infusion to help weight loss – add in salad for iodine taste



Medicinal uses

Anti-cancer properties, enhance therapeutic effects of conventional therapy for example, works on inflammation, helping patient to reduce fatigue after chemotherapy, boosting key immune cells.

Fucoidan from algae is a sulphated polysaccharide characterized by fucose monomers

Seanactiv

Fucus vesiculosus algae

Seanactiv



Traceable supply chain from Nova Scotia region in Canada

Manually harvested with a seaweed rake from platform vessel, from May to September under government license,



in line with good collection practices that ensure regeneration of the biomass.



Organic certified Thallus



Criteria to select specimens to be harvested based on their size



Quota of biomass collection per specimen

Compared to other algae, *Fucus vesiculosus* contains the highest level of the polysaccharide fucoidan



Seanactiv Process characterization

**Fucus
vesiculosus
thallus**

Organic solvent free and
selective extraction

Concentration
Separation & Filtration

Standardization in dry matter

Characterization in fucoidan

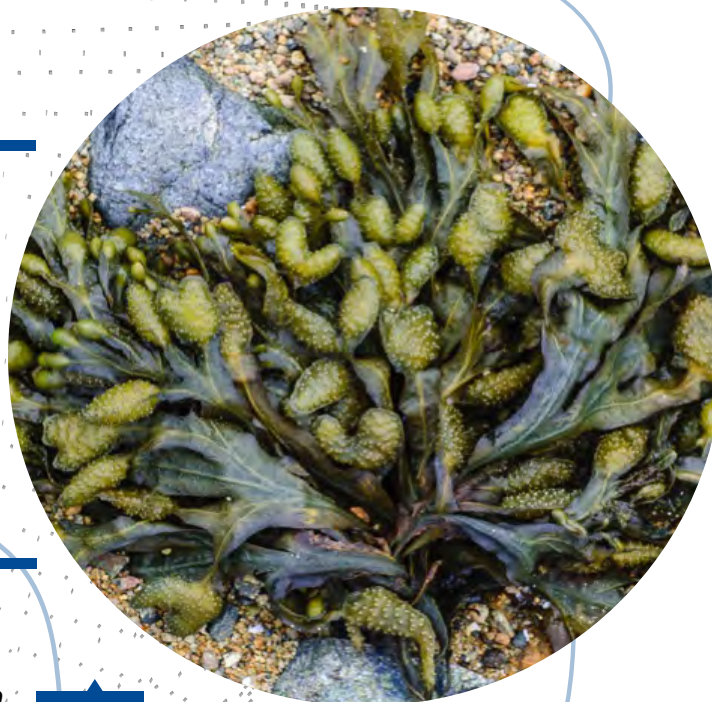

FUCOIDAN characterization of Seanactiv

Phytochemical composition of the selective extract
(mean of 5 representative batches on dry matter and vs
standardisation dry matter)

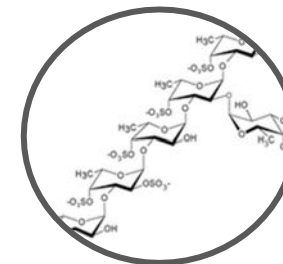

50kDa

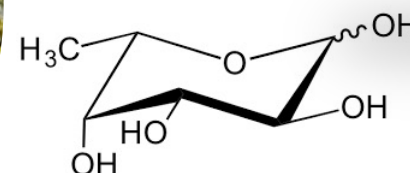

20-36%
of fucose

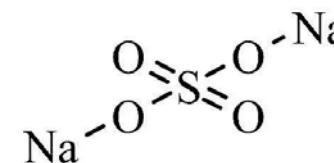

~ 1.6
mol of
sulfate/mol
of fucose

Corresponding
approximately to

~50%
Of
fucoidan

Seanactiv
will act in
3-steps
to
QUICKLY
improve
the eye-
contour
area

FIGHT DARK CIRCLES



FIGHT SIGNS OF AGING

1

DARK CIRCLES REDUCER

Boosting HO-1 enzyme for a
lighter and healthier eye
contour area



↗ HO-1

2

CROW'S FEET REMOVER

Collagen I stimulation
for a younger skin
appearance



↗ COLLAGEN I

3

VITALITY ENHANCER

Even skin tone by reducing
dullness, improving eye
luminosity



↗ SIRT-1

FOCUS Activity of fucoidan

Concept proof

We have evaluated a standard pure molecule of fucoidan on the 3 biomarkers linked to eye contour improvement.



+567%

Heme-Oxygenase 1



+443%

Collagen I



+44%

Sirtuin 1



Seanactiv Agenda

Consumer request for the eye contour

What are the needs? How is eye contour affected?
Our solutions?

Interest for Algae → Seanactiv

Why algae are good for skin?
What is our algae extract?
Our Unique Selling Proposal

Seanactiv package efficacy

In Vitro and *in vivo* package on the 3
biomarkers linked to eye contour
improvement
Characteristic and concept



Study Package

In vitro



Evaluation of Seanactiv efficacy on the 3 proteins :

- HO-1
- COL I
- SIRT-1



In vivo



Application period



Panel inclusion criteria

- 24 females / 18-65 years old
- Crow's Feet Wrinkles
- Dark circles



Test products

- Placebo emulsion
- Emulsion with 1% **Seanactiv**



Clinical assessment

3 Parameters:

- Dark circles
- Crows' feet wrinkles
- Luminosity of the skin

Measurement points every day:

- Short period application (D1 to D7)
- Long period application (D1 to D28)

Methodology:







At home, day-to-day image acquisition with connected SkinCam Device measurements @ wake up, (before morning product application).



Tool of *in vivo* study

Use of Skincam Imagery Device for at-home Tracking Skin Daily Change



-  **Multi-mode acquisition**
Cross-polarized, standard acquisitions
-  **Skin measurement**
2 cm diameter
-  **Multi lighting modalities**
Cross-polarized, standard, 3D modalities
-  **High resolution sensor**
Capture very small skin effects
-  **Integrated quality control**
Very efficient image quality checking
-  **Cloud connected**
Transparent and fast image transfer

Using technologies and innovations



*Tracking skin issues -
Understanding skin reactions -
More Experiential - Convenient*

Easy to use

Ingenious device

Smart Phone Connection



1. DARK CIRCLE REDUCER

When blood vessels located below the skin are affected by stress, fatigue, aging,... the hemoglobin they carry releases "Heme" a cytotoxic molecule for the skin. **HO-1**, a powerful enzyme naturally exists in the skin, helps fight the deleterious effects of Heme. By boosting this enzyme, we protect the skin from the undesired HEME and the associated undesired shadows.

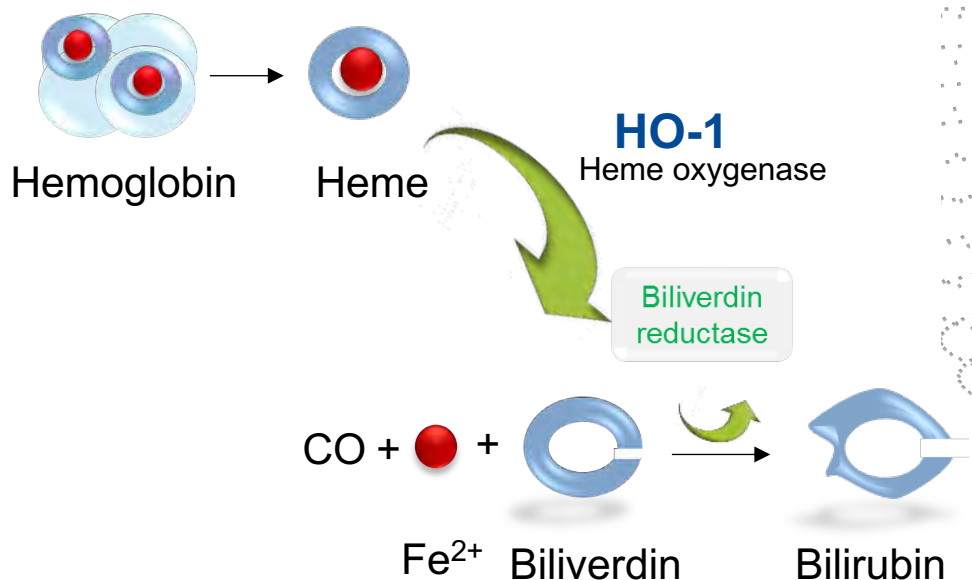
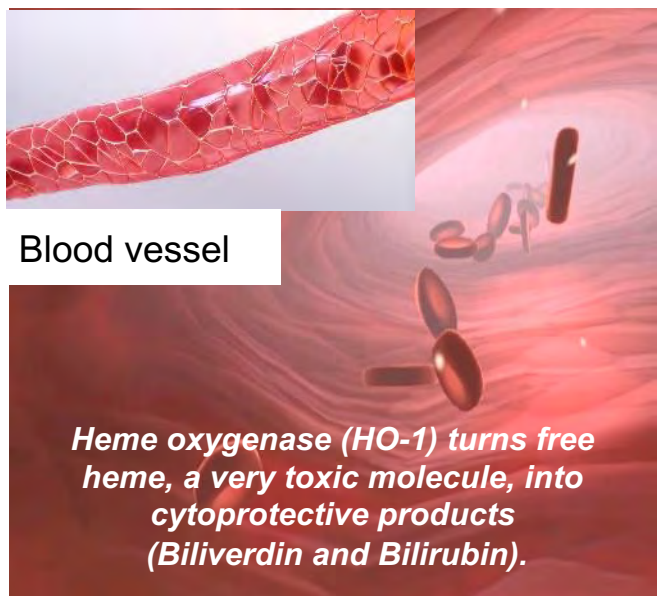

DARK CIRCLE REDUCER

Boosting HO-1 enzyme for a lighter and healthier eye contour area

↗ HO-1

Stimulating HO-1 will help to reinforce cytoprotection and to limit the appearance of dark circles

NOTE: The above claims may not be used in any promotion, marketing, or information relating to products intended for sale or reasonably anticipated for use in the United States.



1. DARK CIRCLES REDUCER – *In Vitro*

Seanactiv strongly stimulates Heme-Oxygenase production

The activity of Seanactiv is supported by its richness in fucoidan

Seanactiv increases the HO-1 protein by

+598%

Stimulation of HO-1 protein

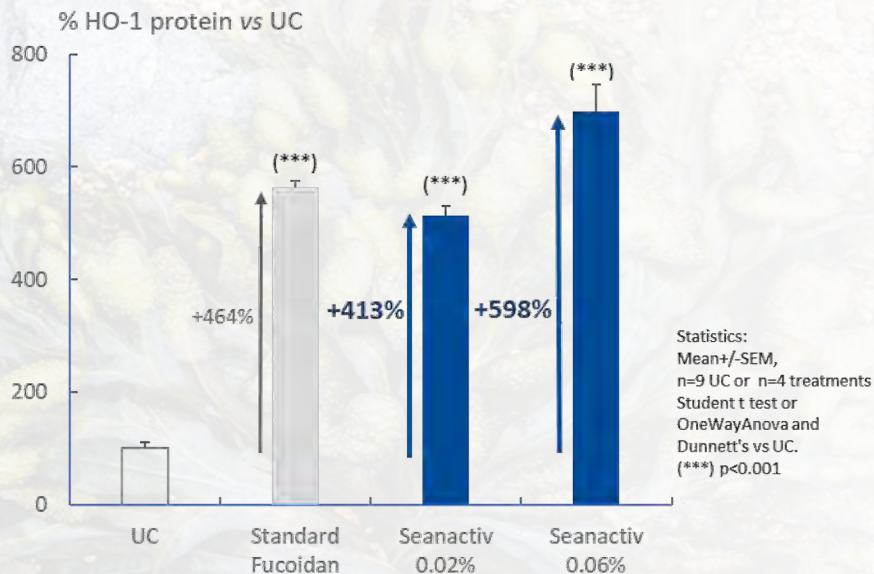

Method: Application of a treatment on keratinocyte monolayers ; 72h treatment with Seanactiv or standard molecule of fucoidan 0.001% (w/w); Measurement: HO-1 synthesis by Western blot



1. DARK CIRCLE REDUCER – *In Vivo*

Seanactiv demonstrates a fast decrease of dark circle color vs placebo



Dark circle reduction of **- 8%** vs PI from the first week



Dark circle reduction of **- 7%** vs PI during a longer period

Seanactiv helps to reduce dark circle discoloration

Significant decrease of the average coloration of dark circle

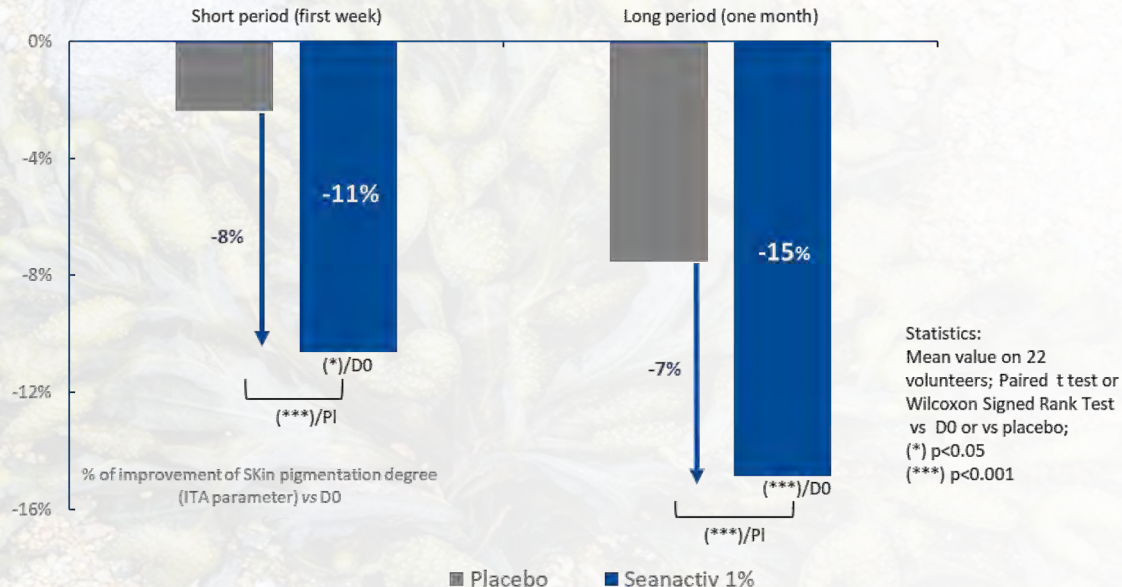

BASF
We create chemistry

Care
Creations.



1. DARK CIRCLE REDUCER

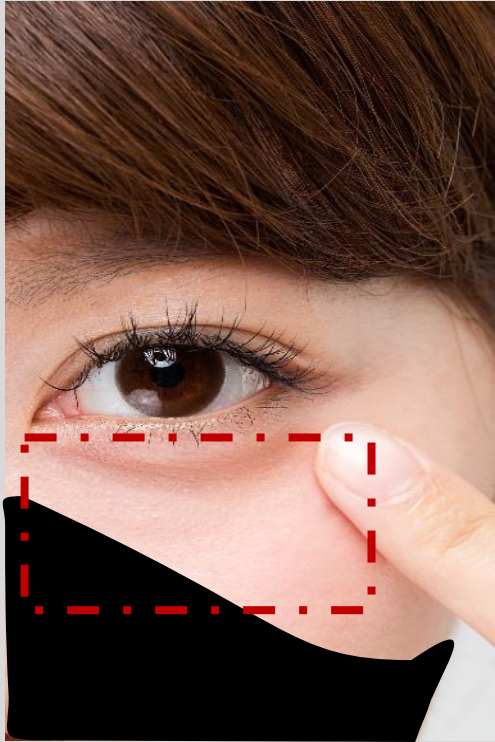

VISIA Representative Images,
Dark circles

Placebo



© BASF BCS



© BASF BCS



© BASF BCS

Seanactiv 1%



© BASF BCS



© BASF BCS



© BASF BCS

Seanactiv shows visible benefits on dark circle reduction from the first week of application onward



2. WRINKLE REMOVER

Wrinkles and fine lines are linked to a loss of Collagen I. The skin looks tired and fine lines eventually become deep wrinkles.

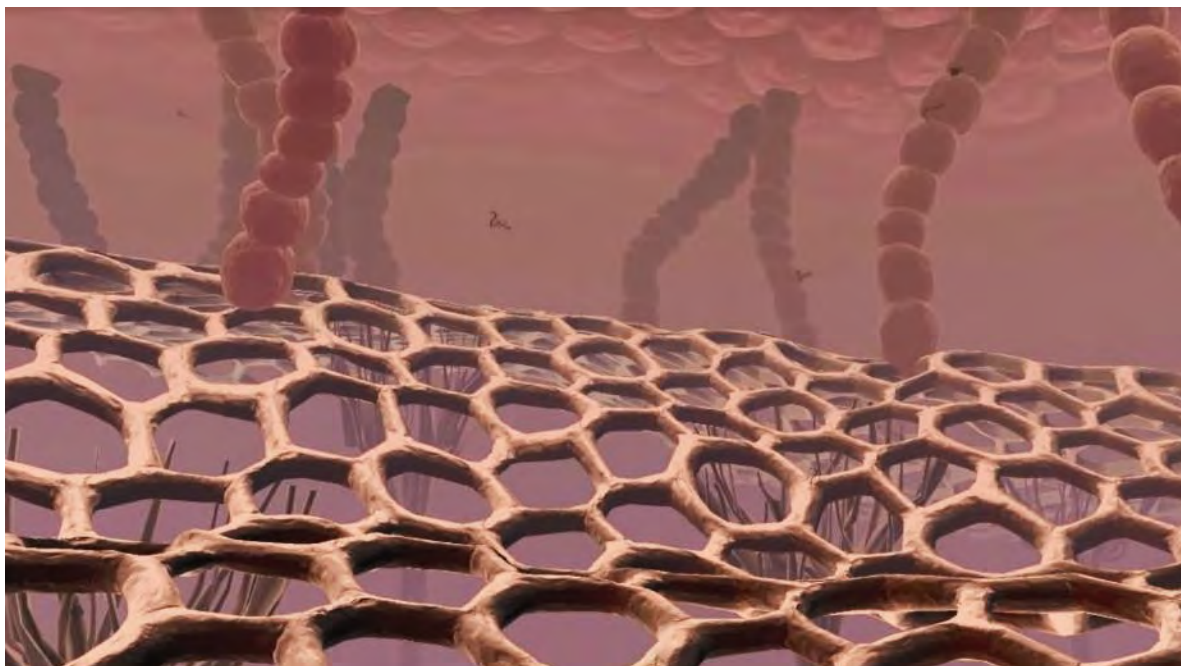

**Increase synthesis of Collagen
to improve crow's feet appearance**

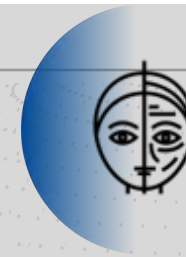

CROW'S FEET REMOVER

Collagen I stimulation
for more youthful skin
appearance



➤ COLLAGEN I

BASF
We create chemistry

Care
Creations.

NOTE: The above claims may not be used in any promotion, marketing, or information relating to products intended for sale or reasonably anticipated for use in the United States.



2. WRINKLE REMOVER – *In Vitro*

Seanactiv strongly stimulates Collagen I production

The activity of Seanactiv is supported by its richness in fucoidan

Stimulation of COL I protein

% COL I protein vs UC

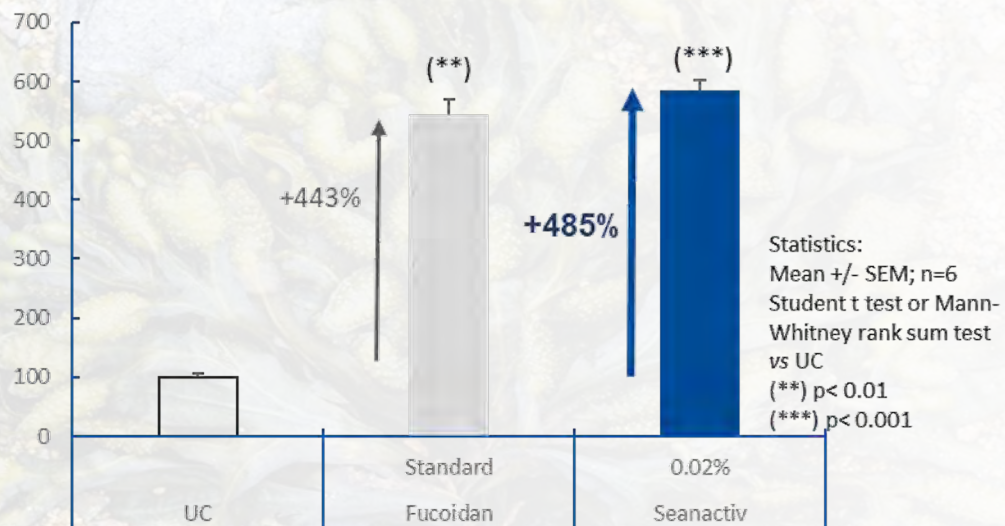

Method: Application of a treatment on fibroblasts monolayers ; 48h treatment with Seanactiv
Measurement: COL I synthesis with DELFIA

Seanactiv increases the COL I protein by

+485%

BASF
We create chemistry

Care
Creations



2. WRINKLE REMOVER – *In Vivo*

Seanactiv demonstrates an express improvement of Crow's feet wrinkles vs placebo



-7% of crow's feet vs PI from the first week



-6% of crow's feet vs PI during a long period

Seanactiv helps to reduce crow's feet

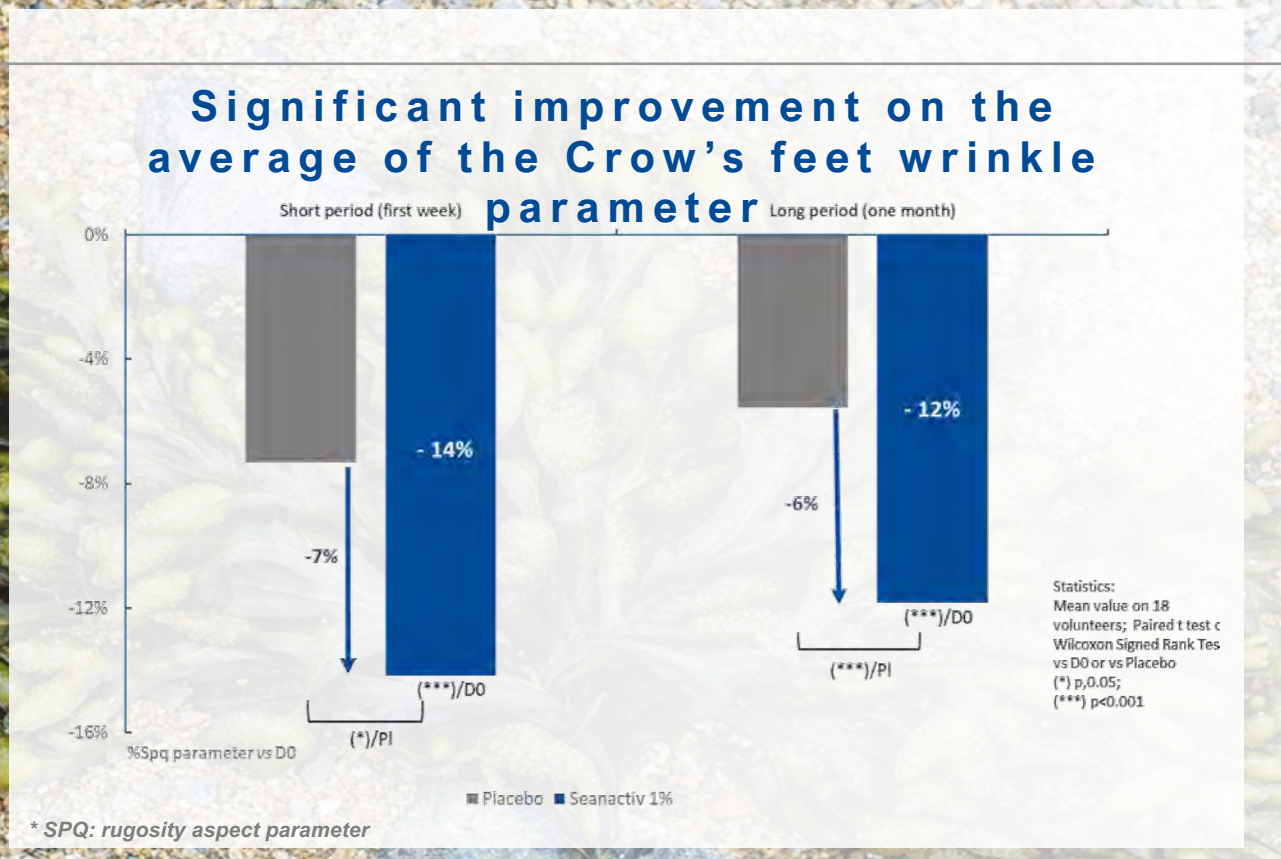

BASF
We create chemistry

Care
Creations.



2. WRINKLE REMOVER



*SkinCam Representative
Images, Crow's Feet – Parallel
Polarized*

Placebo

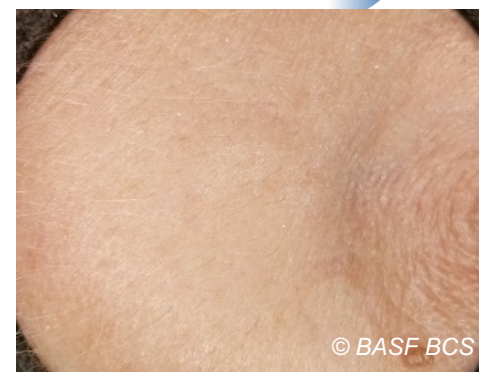

Seanactiv 1%

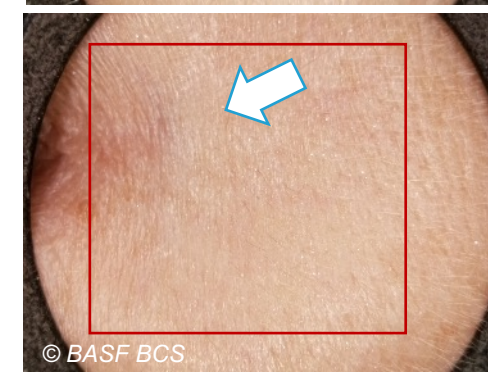
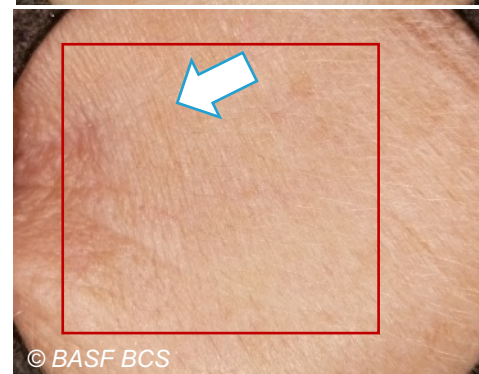

Seanactiv shows visible benefits on crow's feet reduction from the first week of application and after

NOTE: The above claims may not be used in any promotion, marketing, or information relating to products intended for sale or reasonably anticipated for use in the United States.



3. VITALITY ENHANCER

Dullness and tiredness are linked to cell senescence, lack of cell energy and lack of skin defense due to aging. A decrease of SIRT-1 could be one factor making the eye appearing devitalized, lack of energy.

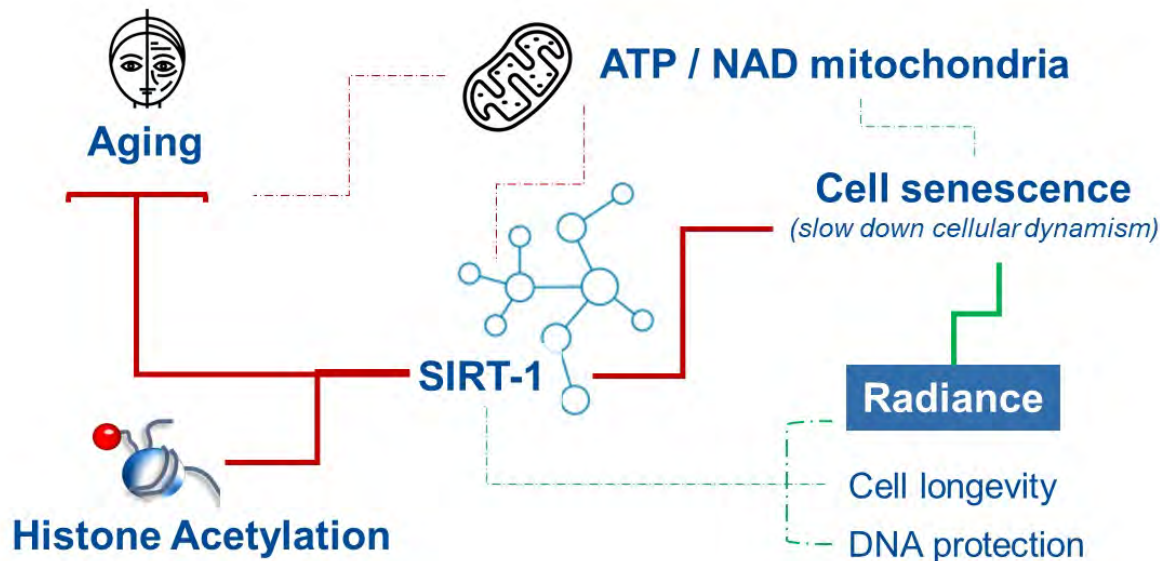

Stimulating SIRT-1 to remove epigenetic mark accumulations will help to decrease cell senescence and to improve eye energy and luminosity



VITALITY ENHANCER

Even skin tone by reducing dullness, improving eye luminosity



↗ SIRT-1

BASF
We create chemistry

Care
Creations.

NOTE: The above claims may not be used in any promotion, marketing, or information relating to products intended for sale or reasonably anticipated for use in the United States.



3. VITALITY ENHANCER – *In Vitro*

Seanactiv strongly stimulates the longevity protein SIRT-1 production

The activity of Seanactiv is supported by its richness in fucoidan

Stimulation of SIRT-1 protein expression

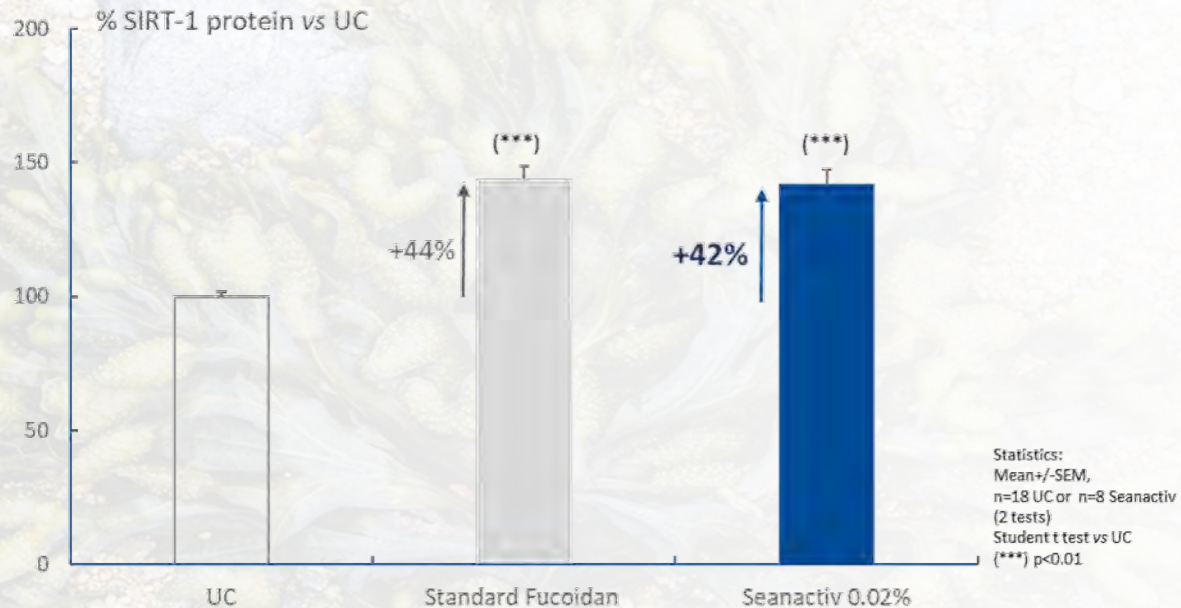

Method: Application of a treatment on fibroblasts monolayers ; 24h treatment with Seanactiv ; Measurement: SIRT-1 synthesis with Sally Sue Western blot ;

Seanactiv increases the longevity protein SIRT-1 by

+42%

BASF
We create chemistry

Care
Creations.



3. VITALITY ENHANCER – *In Vitro*

Seanactiv strongly stimulates cellular dynamism system

Mitochondrial activity and ATP production are closely related to the histone modifier SIRT-1 to help to maintain the cellular dynamism

Mitochondrial activity

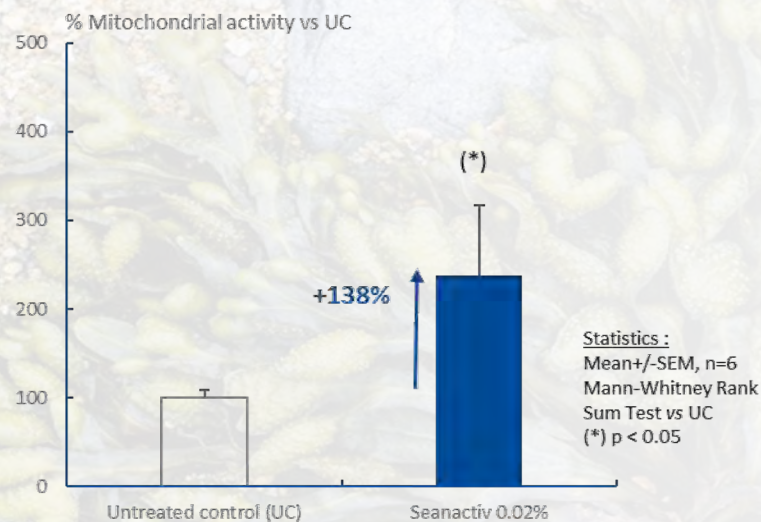

Method: Application of a treatment on fibroblasts monolayers ; 24h treatment with Seanactiv ; Measurement: mitochondrial activity with spectrometry

ATP production

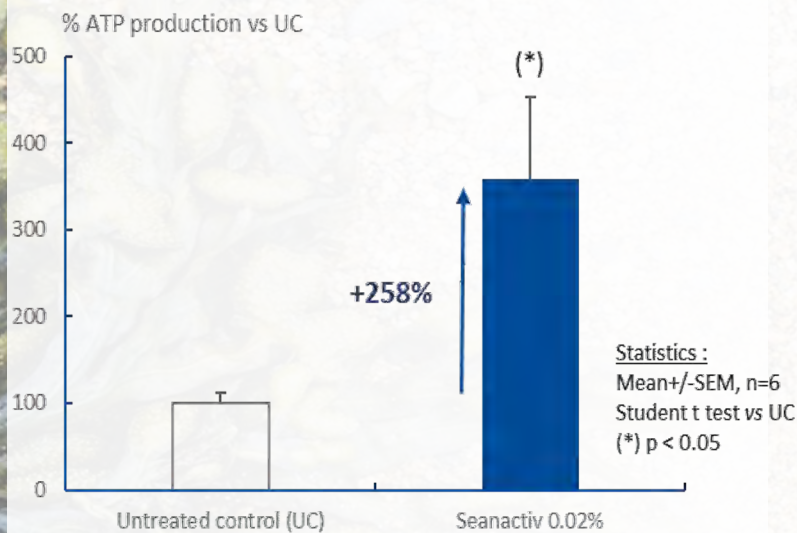

Method: Application of a treatment on fibroblasts monolayers ; 24h treatment with Seanactiv ; Measurement: ATP production with luminescent assay

Seanactiv
Increases
mitochondrial activity by

+138%

+ ATP Production of

+258%

BASF
We create chemistry

Care
Creations.



3. VITALITY ENHANCER – *In Vivo*

Seanactiv shows an express improvement of eye area luminosity vs placebo



+2% vs PI
from the first week

Significant improvement of the average of the skin luminosity parameter

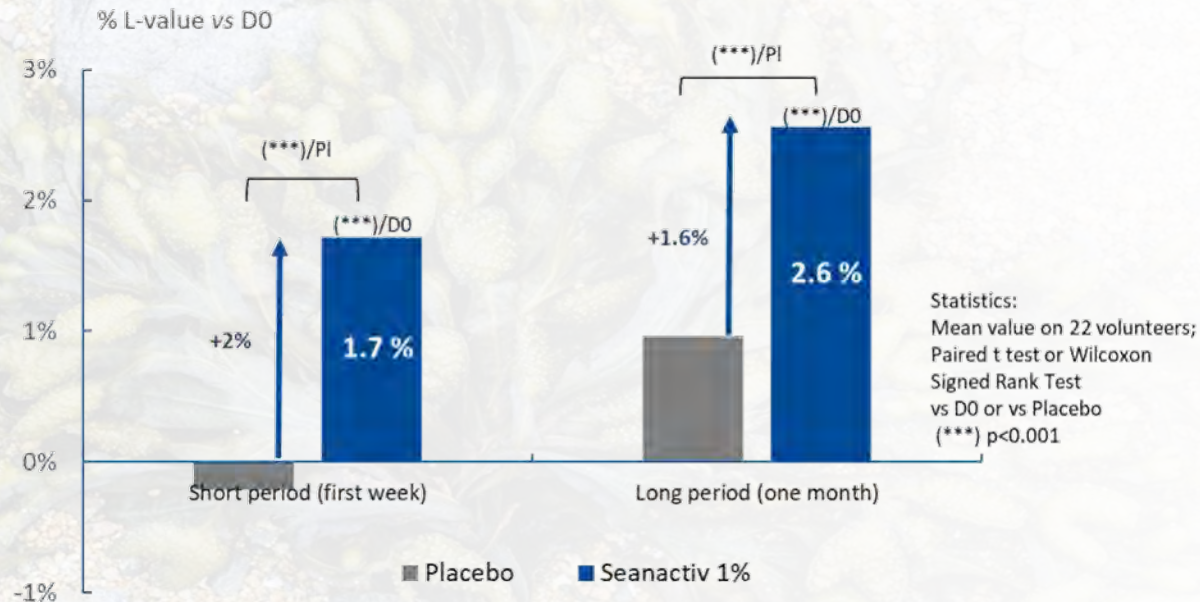

Seanactiv helps to improve eye contour luminosity



3. VITALITY ENHANCER

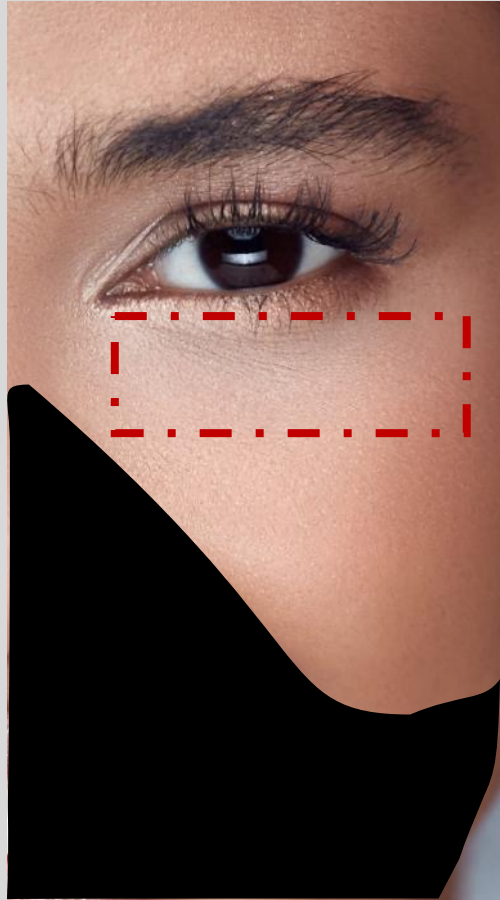

*SkinCam Representative
Images, Crow's Feet – Parallel
Polarized*

Placebo



Seanactiv 1%



Seanactiv shows visible benefits on eye contour
luminosity within the first week and after

Seanactiv
will act in
3-steps
to
QUICKLY
enhance
the eye-
contour
area

FIGHT DARK CIRCLES

1

DARK CIRCLES REDUCER



Reduction of - **8%** vs PI
from the first week

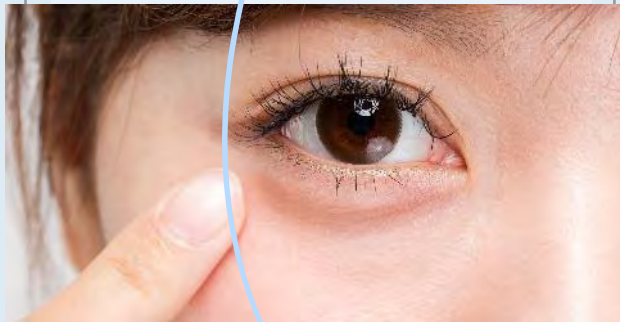

HO-1 +598%



FIGHT SIGNS OF AGING

2

CROW'S FEET REMOVER



- **7%** vs PI
from the first week



COLLAGEN I +485%

3

VITALITY ENHANCER



+2% vs PI
from the first week

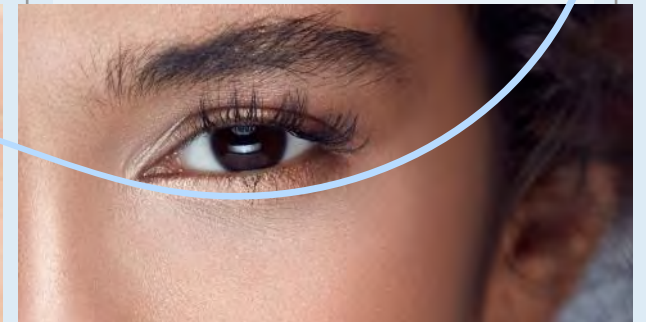

SIRT-1 +42%

#menwomen

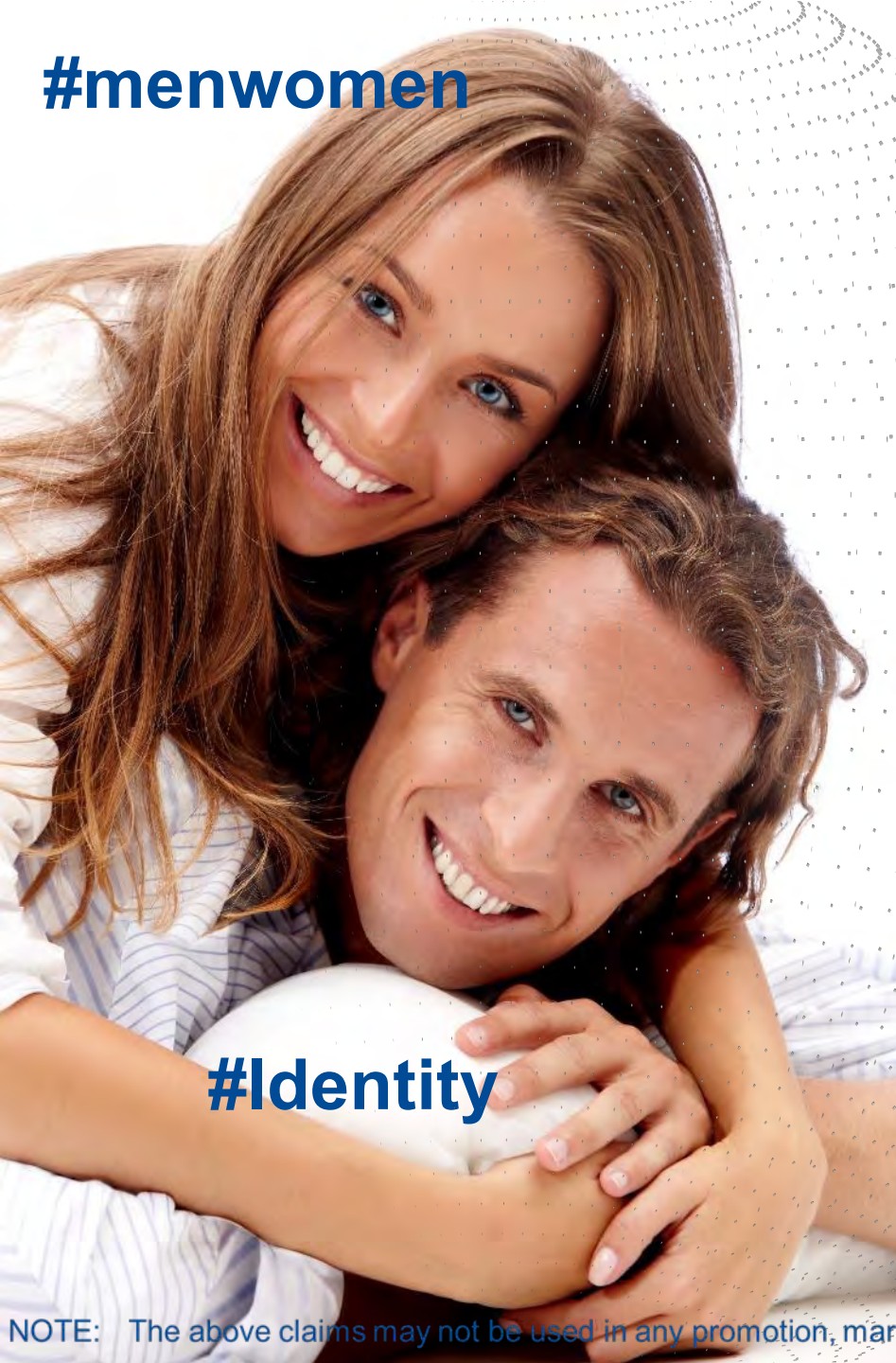

#Identity

UNIVERSAL CC EYE PERFECTOR

With this UNIVERSAL CC EYE PERFECTOR, enriched with a fucoidan extract – **Seanactiv** – we will offer a real shot of youthfulness for the eye in only 7 days!

- **Fade dark circles [-8%]**



- **Remove crow's feet [-7%]**



- **Improve eye luminosity**



The perfect ally to
recover a healthy
look in only 7 days,



with a touch of
matching color!



SILKY *Eye* CONCENTRATE

No one loves to see unwanted signs of fatigue and aging, crisscrossing their eyes. This new eye serum enriched with high content of fucoidan, will be adapted to all skin needs thanks to its epigenetic pathway, able to stimulate protein of longevity, to rebuilt your entire eye-contour.



The richness of fucoidans to reveal eye beauty



Dark circle remedy to optimize eye area



When waking-up, eye area is visibly younger, brighter, more rested

Breathtaking results in only one week



Erase signs of aging by keeping own identity

#personnalization

#keepsmiling

#selfesteem

NOTE: The above claims may not be used in any promotion, marketing, or information relating to products intended for sale or reasonably anticipated for use in the United States.

Seanactiv Regulatory data

BC10113	Seanactiv™												
Description	Extract of brown algae <i>Fucus vesiculosus</i> characterized in fucoidan												
Aspect	Dark red-amber viscous liquid												
Solubility	Soluble in water												
Preservative system	Sodium Benzoate												
INCI	Water (and) Fucus Vesiculosus Extract (and) Gluconolactone (and) Xanthan gum (and) Sodium chloride												
Natural label	COSMOS approved												
Natural origin content (ISO 16128)	99.8%												
Dose of Use	1 %												
Regulatory data	<table border="1"> <thead> <tr> <th>PCPC</th> <th>IECSC</th> <th>IECIC 2015</th> <th>REACH</th> <th>JP cosmetics</th> <th>QD additive</th> </tr> </thead> <tbody> <tr> <td>On going</td> <td>✓</td> <td>✓</td> <td>✓</td> <td>✓</td> <td>X</td> </tr> </tbody> </table>	PCPC	IECSC	IECIC 2015	REACH	JP cosmetics	QD additive	On going	✓	✓	✓	✓	X
PCPC	IECSC	IECIC 2015	REACH	JP cosmetics	QD additive								
On going	✓	✓	✓	✓	X								

Seanactiv Formulation & storage conditions

Formulation method

Incorporated below
40°C or at room
temperature for a
cold process.
pH 3-11

OK at Room T°,
slight color change
at 45°C

Storage conditions

In its original
packaging at
10-30°C

Shelf life:
18 months



Color impact



Formulation of the clinical study

Phase	Trade Name	INCI Name	%
A	Eau osmosée	Water	76,23
	Euxyl PE 9010 (Schülke)	Phenoxyethanol, Ethylhexylglycerin	1,00
	Glycerine 99-5	Glycerin	3,00
	EDETA® BD	Disodium EDTA	0,05
B	Cosmedia® SP	Sodium Polyacrylate	0,20
C	Emulgade® PL 68/50	Cetearyl Glucoside, Cetearyl Alcohol	5,00
	Cutina® PES	Pentaerythrityl Distearate	1,50
	Cutina® HVG	Hydrogenated Vegetable Glycerides	1,50
	Myritol® 331	Cocoglycerides	3,00
	Cetiol® CC	Dicaprylyl Carbonate	5,00
	Cegesoft® PFO	Passiflora Incarnata Seed Oil	3,00
	Xiameter PMX-200 Silicone Fluid 350CS (Dow Corning)	Dimethicone	0,50
D	Seanactiv BC10113	See composition sheet	0,00
	Sodium Hydroxide solution 16%	Sodium Hydroxide, Water	0,020

Process

1. Heat Phase A and C at 80°C
2. Introduce phase B in phase A while stirring
3. Introduce phase C in phase A+B while stirring. Homogenize at 50°C with Ultra Turrax
4. Add phase D at 30°C. Adjust pH to pH 6,1-6,3

Specifications:

pH = 6,27

Viscosity = 70 000 mPas (Brookfield RVT, spindle C, 20 rpm)



#menwomen

UNIVERSAL **CC** EYE PERFECTOR

Phase	Ingredients	INCI	% by weight	Function
A	Dehymuls® PGPH	Polyglyceryl-2 Dipolyhydroxystearate	5.00	Emulsifier (W/O)
	Lameform® TGI	Polyglyceryl-3 Diisostearate	2.00	Emulsifier (W/O)
	Cutina® PES	Pentaerythrityl Distearate	1.50	Structurant
	Cosmedia® Gel CC	Dicaprylyl Carbonate, Stearalkonium Hectorite, Propylene Carbonate	7.00	Rheology modifier
	Cetiol® Sensoft	Propylheptyl Caprylate	7.00	Emollient
	DOWSIL 9041 Silicone Elastomer Blend (Dow Corning)	Dimethicone, Dimethicone Crosspolymer	2.00	Skin feel modifier
B	Water, demin.	Aqua	56.94	
	1,3-Butanediol	Butylene Glycol	2.00	Humectant
	Magnesium Sulfate	Magnesium Sulfate	1.00	Stabilizer
	Preservative		q.s.	Preservative
C	Cetiol® A	Hexyl Laurate	4.00	Emollient
	Cetiol® C 5C	Coco-Caprylate/Caprates	4.00	Emollient
	DK-PGT Paste Ti	Polyglyceryl-2 Triisostearate, Titanium Dioxide, Aluminum Hydroxide	3.00	Colorant
	(Dajito Kasei Kogyo)			
D	Chione™ M SVA	Synthetic Fluorophlogopite, Lauroyl Lysine	2.00	Skin feel modifier
	Timica® Terra Yellow MN4502	Mica, Iron Oxides, Titanium Dioxide	1.10	Effect pigment
	Timica® Terra Red MN4506	Mica, Iron Oxides, Titanium Dioxide	0.33	Effect pigment
	Timica® Terra Black MN4498	Mica, Iron Oxides, Titanium Dioxide	0.13	Effect pigment
	Seanactiv™ BC10113	See Composition Sheet	1.00	Active ingredient

Specifications

Viscosity
(Brookfield; RVT; spindle TC, Helipath; 20 rpm; 20°C) 17000 mPa s

Appearance Beige fluid

Process

1. Heat Phases A and B to 80°C under stirring.
2. Add Phase C into Phase A under stirring.
3. Add Phase B into Phase A+C under stirring.
4. Add phase D under stirring.
5. Cool down to 30°C, then add Phase E under stirring.

#Identity

Seanactiv

Use the power of fucoidan to quickly erase eye-aging and improve healthy radiance



Algae extract, **concentrated and characterized in fucoidan**, well-known for healthy benefits



The eye-contour partner to beautify your eye contour, thanks to a demonstrative *in vitro* results: **HO-1, Collagen I, and SIRT-1.**



3-step action of the Eye-coach to rejuvenate the eye contour, with **visible and express results from the first week**, allowing to reduce **dark circle, wrinkles and dullness** (luminosity).

From the first week

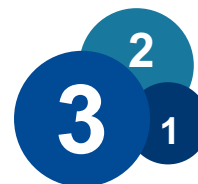

Dark circles are reduced
Crow's feet are fading
The eye contour looks healthier, fresher

Contact us! Order a Sample!

- North America Care Creations website: <https://carecreations.basf.us/login?return=/>
- Meg Mullen: Margaret.mullen@basf.com
- Allison Garlet: Allison.garlet@basf.com

DISCLAIMER

While the descriptions, designs, data and information contained herein are presented in good faith and believed to be accurate, it is provided gratis and for your guidance only. Because many factors may affect processing or application/use, we recommend that you make tests to determine the suitability of a product for your particular purpose prior to use. NO WARRANTIES OF ANY KIND, EITHER EXPRESS OR IMPLIED, INCLUDING WARRANTIES OF MERCHANTABILITY OR FITNESS FOR A PARTICULAR PURPOSE ARE MADE REGARDING PRODUCTS DESCRIBED OR DESIGNS, OR THAT DATA OR INFORMATION MAY BE USED WITHOUT INFRINGING THE INTELLECTUAL PROPERTY RIGHTS OF OTHERS. IN NO CASE SHALL THE DESCRIPTIONS, INFORMATION, DATA OR DESIGNS PROVIDED BE CONSIDERED A PART OF OUR TERMS AND CONDITIONS OF SALE.

For more information visit us at www.personal-care.basf.com or www.carecreations.basf.com

We create chemistry

Care
Creations™